

**25** Years  
REHAU  
India

Our verbal and written advice relating to technical applications is based on experience and is correct to the best of our knowledge, but is given without obligation.

The use of REHAU products in conditions that are beyond our control or for applications other than those specified releases us from any obligation in regard to claims made in respect of the products.

We recommend that the suitability of any REHAU product for the intended application should be checked. Utilisation and processing of our products are beyond our control and are therefore exclusively your responsibility. In the event that a liability is nevertheless considered, any compensation will be limited to the value of the goods supplied by us and used by you.

Our warranty assumes consistent quality of our products in accordance with our specifications and in accordance with our general conditions of sale.

This document is protected by copyright. All rights based on this are reserved. No part of this publication may be translated, reproduced or transmitted in any form or by any similar means, electronic or mechanical, photocopying, recording or otherwise, or stored in a data retrieval system.

## REHAU Experience Centres

### DELHI

REHAU Polymers Pvt. Ltd.  
88, 2<sup>nd</sup> Floor, Furniture Block,  
Kirti Nagar, New Delhi - 110015, India  
Contact Details: 011-4848 5600

### BENGALURU

REHAU Polymers Pvt. Ltd.  
48, Richmond Road,  
Bengaluru - 560025, India  
Contact Details: +91 80 2222 0014

## REHAU Sales Offices

### DELHI

REHAU Polymers Pvt. Ltd.  
88, 2<sup>nd</sup> Floor, Furniture Block,  
Kirti Nagar, New Delhi - 110015, India  
Contact Details: 011-4848 5600

### BENGALURU

REHAU Polymers Pvt. Ltd.  
48, Richmond Road,  
Bengaluru - 560025, India  
Contact Details: +91 80 2222 0014

### PUNE

REHAU Polymers Pvt. Ltd.  
601/602, 6<sup>th</sup> Floor, Nucleus Mall,  
1 Church Road, Camp,  
Pune - 411001, Maharashtra, India

### MUMBAI

REHAU Polymers Pvt. Ltd.  
Affairs Building, 903, 9<sup>th</sup> Floor, Plot No. 4, Sec - 17  
Palm Beach Road, Sanpada, Navi Mumbai - 400705, India  
Contact Details: 022-2757 4783

Email: [customer.care.fs@rehau.com](mailto:customer.care.fs@rehau.com) • Toll Free No.: 1800 2100 011

Follow REHAU India: [f](#) [t](#) [in](#) [i](#)

Download REHAU India App at [Google Play Store](#)



[www.rehau.co.in](http://www.rehau.co.in)

Engineering progress  
Enhancing lives

# RAUSHELL Bravura

Weather Resilient  
External Cladding for Lasting  
Radiance



# RAUSHELL Bravura

REHAU India has come up with yet another remarkable product in the market – RAUSHELL Bravura. These facade panels are considered to be an innovative solution for all types of construction needs. RAUSHELL Bravura is a HPL compact laminate with an intrinsic surface, manufactured using conventional PMMA based UV film or hot coating technology.

It's made with a blend of cellulose fibres and thermosetting resins, under high pressure and temperature. Available in a wide range of colours, RAUSHELL Bravura is the perfect external cladding solution that can conveniently be used in combination with other materials.

## HPL Compact:

- Exterior Decorative Panels are manufactured by: Impregnating large amount of Kraft papers having resin-absorbing capability
- Pressing under high temperature of 180 °C -220 °C and pressure of 120 kg/ cm<sup>2</sup>

## Both side decor

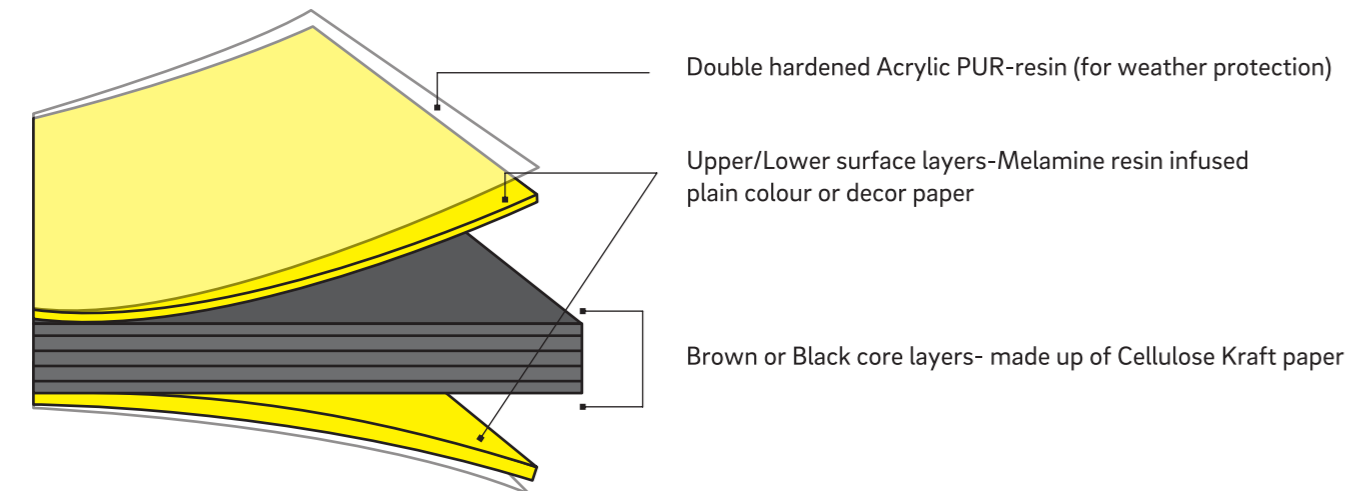



### Available Colours

Woodgrains : 10 (Ready Stock)  
 Stones : 8 (on Request)  
 Solid : 7 (on Request)

### Available Size

2440mm x 1220mm x 6mm



### High UV stability

A special UV protected treatment makes the claddings UV resistant and prevents discoloring under long exposure to direct sunlight

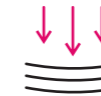

### Impact resistant

It is impact resistant and has a very good modulus of elasticity due to the modified phenolic resin.



### Weather resistance

Highly weather resistant even when exposed to extreme cold or heat conditions and extreme levels of humidity.



### Graffiti resistant

Any writing made on the panel surface can be easily removed using recommended cleaning agent.



### Good chemical resistance

Designed for environments highly prone to chemicals (Limited) and harsh solutions



### Easy to clean & low maintenance

It is easy to clean and maintain.



### Fire retardant

Claddings are resistant to high temperatures and flame conditions. Bravura is available with flame retardant grade.



### Scratch resistance

It is highly scratch resistant and has a very good modulus of elasticity due to the modified phenolic resin.



### Wear & abrasion resistance

REHAU Bravura has superior abrasion and wear resistance capabilities which gives it better lifespan.



### Termite resistance

RAUSHELL Bravura is highly resistant to termite and fungal attack.



### Non corrosive panel

Absolutely non-corrosive unlike other metallic cladding products.

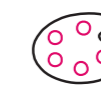

### Wide range of colours

Various color shade

# Application Scope



- 1 Ceilings
- 2 Ventilated Facades
- 3 Balcony Claddings
- 4 Pillars
- 5 Doors
- 6 Highlighter

## Application areas:



Commercial



Hotel and Resort



Residence



Shopping Mall



Retails Shop



Corporate Office



RESIDENCE



SHOPPING MALL



COMMERCIAL

APPLICATION AREAS

# WOODGRAINS



UV RAYS RESISTANCE

Cosco 0101C



Elm 0102C



Maldau 0103C

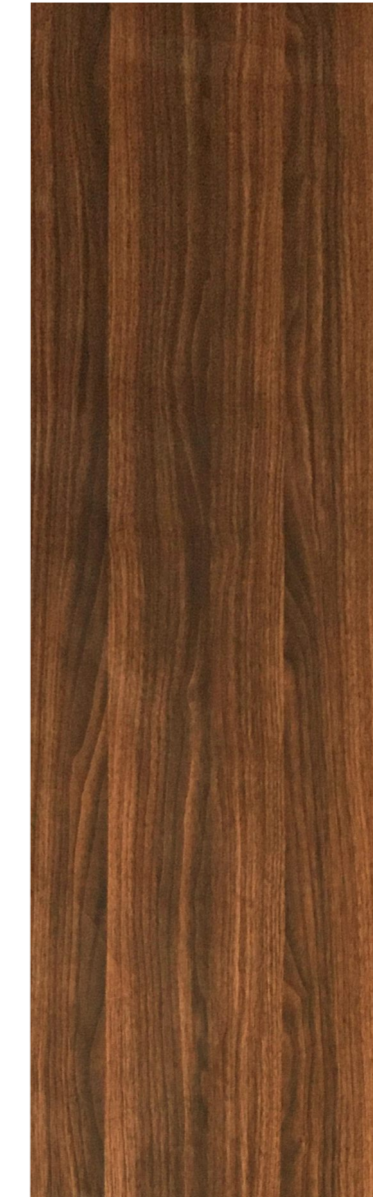

Vintage 0104C



Alaska 0105C

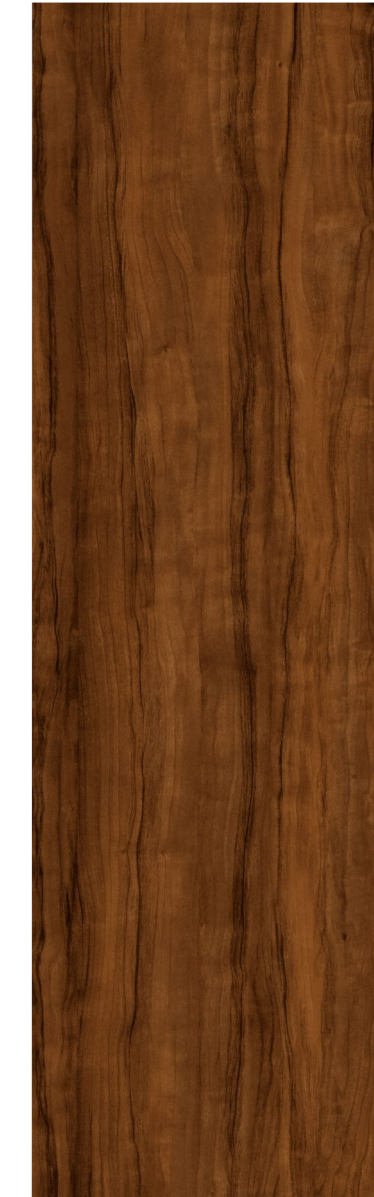

Actual colour may vary from photo shown

**Jamaican 0106C**



**Hampshire 0107C**



**Tropical 0108C**



**Classic 0109C**



**Mariano 0110C**



Actual colour may vary from photo shown

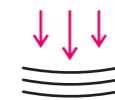

**IMPACT RESISTANCE**



# STONE



**FIRE RETARDANT**

**Matterhorn 2001**



**Denali 2003**



**Aoraki 2005**



**Huangshan 2007**



**Olive 2002**



**Vinicunca 2004**



**Kilimanjaro 2006**



**Castle 2008**



Actual colour may vary from photo shown



# SOLID



**EASY TO CLEAN & LOW MAINTENANCE**



**\*Malarstall 3001**



**Aquamarine 3001**



**\*Parrburn 3001**



**Cochbalt 4001**

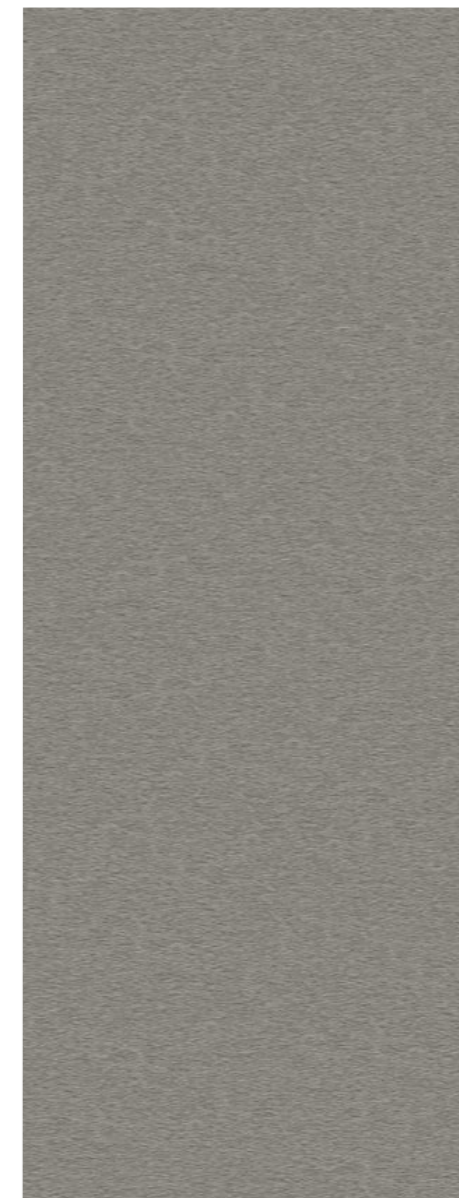

**Serpent 3001**



**\*Tadpole 3001**



**Whitemis 3001**

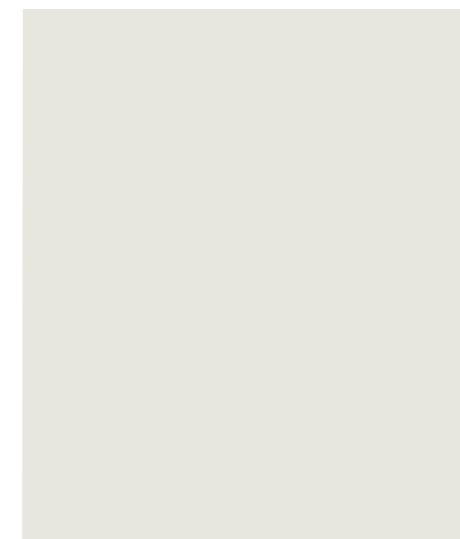

\*Warranty not applicable on solid colour shades for colour fastening.

Actual colour may vary from photo shown

# Technical Specification

SL.#	PROPERTIES	TEST METHOD	ATTRIBUTE OF PERFORMANCE	UNIT	RESULTS (AS PER EN 438-6)
1	Surface Quality	EN 438-2.4	Spots, Dirt and Similar surface defects	mm <sup>2</sup> /m <sup>2</sup>	≤ 2
			Fibres, hairs and scratches	mm/m <sup>2</sup>	≤ 20
2	Thickness	EN 438-2.5	Thickness tolerance	mm	5 ≤ T < 8 : ± 0,4
3	Size	EN 438-2.6	Length and width	mm	+ 10 / - 0
4	Straightness of edges	EN 438-2.7	Straightness of edges	mm/m	≤ 1,5
5	Squareness	EN 438-2.8	Squareness	mm/m	≤ 1,5
6	Flatness	EN 438-2.9	Flatness (measured on full-size sheet)	mm/m	6,0 ≤ T < 10,0 : 5
7	Flexural modulus	EN ISO 178	Stress	Mpa	≥ 9000
8	Flexural strength	EN ISO 178	Stress	Mpa	≥ 80
9	Density	EN ISO 1183	Density	gm/cm <sup>3</sup>	≥ 1,35
10	Resistance to impact with large diameter ball	EN 438-2.21	Indent. dia. 10mm T≥6mm - Drop Height	mm	≥ 1800
11	Resistance to wet conditions	EN 438-2.15	Mass increase - T ≥ 5 mm	Rating	EGS/EDS- ≤ 5,EGF/EDF- ≤ 8
12			Appearance	Rating	≥ 4
13	Dimensional stability at elevated temperatures	EN 438-2.17	Cumulative dimensional change - T ≥5mm	L%	≤ 0,30
				T%	≤ 0,60
<b>WEATHER RESISTANCE REQUIREMENTS</b>					
14	Resistance to climatic shock	EN 438-2.19	Thermal Shock Resistance -Appearance	Rating	≥ 4
15	Resistance to artificial weathering	EN 438-2.29	Contrast	Grey scale rating	≥ 3
16			Appearance	Rating	≥ 4
<b>FIRE PERFORMANCES</b>			<b>Test as per EN 13823 (SBI test) and EN ISO 11925-2 (Small-burner test)</b>		
17	Fire Reaction Classification, EGF-EDF	EN 135 01	Classification - T ≥ 6 mm	Rating	B - s1, d0
<b>OTHER PROPERITES</b>					
19	Release of Formaldehyde	EN 438-7.4.11.1	Classification	Rating	E1

# Product Warranty:

RAUSHELL Bravura warrants that, under normal use and service, the product shall conform to the standards EN 438-6 set forth on the data sheet for a period of 10 years against colour fastness and mechanical strength beginning from related invoice date, as per the technical datasheet.

- Warranty will be valid when installation will be done according to REHAU's installation Guideline under technical supervision.

**Product Warranty:** REHAU warrants that under normal use of RAUSHELL Bravura panels, it will conform to the properties as per specification of EN 438-Part-6, for the period of 10 years from the date of invoice of REHAU to the first consumer purchaser, subject to following conditions:

- Slight deviations or homogeneous variations in colour taking place in course of time of use is acceptable as per En438 Part6
- The warranty will be non-transferable and any resale of the product after installation by the first consumer purchaser shall render the warranty void.
- The product warranty don't cover any damage or deviation caused by - a. Accidents, b. Misuse/mishandles, c. improper installation & Maintenance/ Cleaning and REHAU have the absolute right to examine the root cause for such damage.
- In case of any dispute or differences which arise our of these warranty terms, the same will be subject to the jurisdiction of the courts of law in Pune, India.

In the event that the product does not perform as warranted, acceptance pf the product whether, it is defective or not, repair or replace of all or any part, is at REHAU sole discretion.

REHAU will not be responsible for any additional construction material and Labour costs associated with the replacement, Installation or repair and will be limited to the cost of the product only.

Customer is required to submit the original Invoice of REHAU and invoice of dealer to the client related to the project work along with the photographs of completed site, then only this warranty will be considerable. Failing to do so this documents holds of no reference.

**Quality Credential & Test Certificate:** RAUSHELL Bravura undergo rigorous testing to make sure the product meet national & international quality standards. REHAU's Product management team and designers work efficiently to give our customer the freedom to design the exterior wall in immense way.



**RAUSHELL  
Bravura -  
10 Years  
warranty**